

TURNING FROG

1. Product Introduction:

Turning Frog is a robot car which uses microphone as its detector. When the microphone receives signal (like a clap), it will move and repeat the following steps:

Move forward → Stop → Turn left → Stop → Turn right → Stop → Go forward

You will find it is so fun to learn electronic and mechanism by building this Turning Frog.

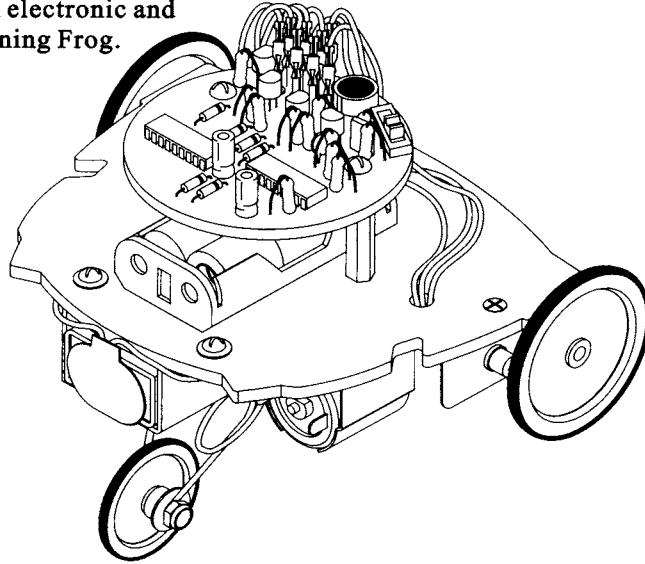



Power Source Required:

Voltage/ Electrical parts: DC9V X 1 battery (not included)

Voltage/ Mechanical parts: DC3V 1.5V "AA"X2 battery (not included)

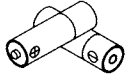
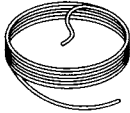
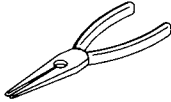
2. Tools You May Need:

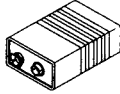
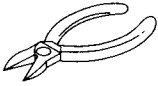
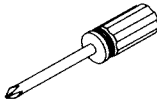
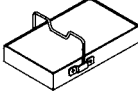
			
AA Battery 2pcs	Solder Wire	Long Nose Pliers	Soldering Iron
			
9V Battery 1 pc	Diagonal Cutter	Screwdriver	Soldering Iron Stand With Sponge

3. Electronic Parts List:

Resistor	
<input type="checkbox"/> 100Ω (brn blk brn gold) 2 pcs	
<input type="checkbox"/> 4.7K (yel vio red gold) 2 pcs	
<input type="checkbox"/> 10K (brn blk ora gold) 1 pc	
<input type="checkbox"/> 22K (red red ora gold) 1 pc	
<input type="checkbox"/> 33K (ora ora ora gold) 5 pcs	
<input type="checkbox"/> 2.7M (red vio grn gold) 2 pcs	

	Battery Snap
	<input type="checkbox"/> Battery Snap with 15cm wires 1 pc

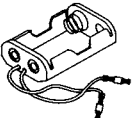
	Battery Holder
	<input type="checkbox"/> holder with 8cm wires 1 pc

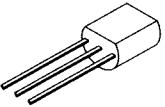
Transistor	
<input type="checkbox"/> 1815 2 pcs or (C945)	
<input type="checkbox"/> 8050 2 pcs	

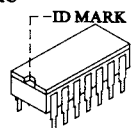
IC	
<input type="checkbox"/> 4017 1 pc	
<input type="checkbox"/> 4069 1 pc	

Ceramic Capacitor	
<input type="checkbox"/> 47P	
1 pc	

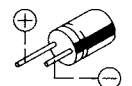
Electrolytic Capacitor	
<input type="checkbox"/> 1uf	
2 pcs	

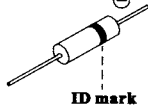
Diode	
<input type="checkbox"/> IN 4148	
6 pcs	

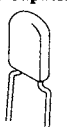
Mylar Capacitor	
<input type="checkbox"/> 103	
1 pc	

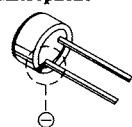
Microphone	
<input type="checkbox"/> Ø10mm	
1 pc	

Variable Resistor	
<input type="checkbox"/> 200K	
1 pc	

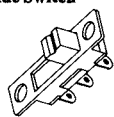
Slide Switch	
<input type="checkbox"/> Slide Switch	
1 pc	

	
<input type="checkbox"/> Ø1.3mm pin	
8 pcs	

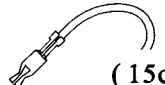
Connector with wire  (15cm)	<input type="checkbox"/> yellow 1 pc
	<input type="checkbox"/> blue 1 pc
	<input type="checkbox"/> orange 1 pc
	<input type="checkbox"/> green 1 pc

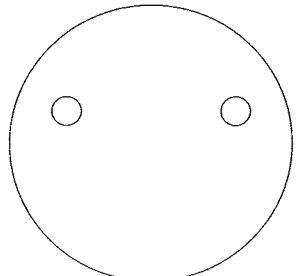
Printed Circuit Board (PCB)

1 pc

4. Mechanical Parts List:

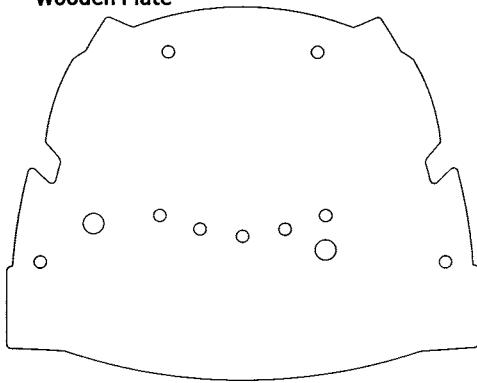
Wooden Plate

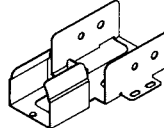

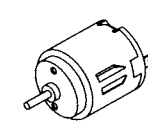
	
No.P1	Gearbox
Qty:	2 pcs

	
No.P2	Motor DC3V
Qty:	2 pcs

	
No.P3	Metal shaft
Qty:	2 pcs (2X40mm)

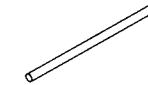
	
No.P4	Metal shaft
Qty:	2 pcs (3X52mm)

	
No.P5	Pinion gear10T
Qty:	2 pcs (white)

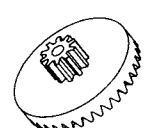
	
No.P6	Face gear 36T/14T
Qty:	2 pcs (white)

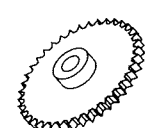
	
No.P7	Gear 36T/0T
Qty:	2 pcs (white)

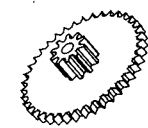
	
No.P8	Gear 36T/14T
Qty:	2 pcs (Red)

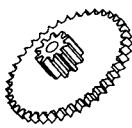
	
No.P9	Gear 36T/14T
Qty:	2 pcs (Green)

	
No.P10	Nylon pad
Qty:	4 pcs (5.6X4.8X1.95)

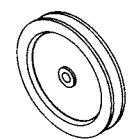
	
No.P11	Rear Wheel
Qty:	2 pcs (∅32X3.5mm)

	
No.P12	Rubber tire
Qty:	2 pcs (∅30X∅3mm)

	
No.P13	Front Wheel
Qty:	1 pc (∅20mm)

	
No.P14	Rubber ring
Qty:	1 pc (∅15X2.5mm)

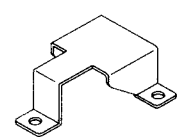
	
No.P15	9V Battery holder
Qty:	1 pcs

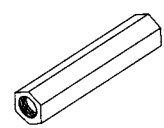
	
No.P16	Hex post
Qty:	2 pcs(M3X25mm)

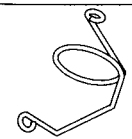
	
No.P17	Right front wheel bracket
Qty:	1 pc

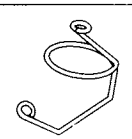
	
No.P18	Left front wheel bracket
Qty:	1 pc

	
No.P19	Nylon post
Qty:	1 pc (∅3X3mm)

	
No.P20	Nylon nut
Qty:	1 pc

	
No.P21	Nut M3
Qty:	2 pcs

	
No.P22	Nut M2
Qty:	5 pcs

	
No.P23	Washer
Qty:	2 pcs (3.2X10X0.5mm)

	
No.P24	Self-taping screw
Qty:	1 pc (2X4mm)

	
No.P25	Screw
Qty:	6 pcs(M3X8mm)

	
No.P26	Screw
Qty:	1 pc(M3X16mm)

	
No.P27	Screw
Qty:	5 pcs(M2X10mm)

5. PCB Assembly:

The parts I.D. (identification) for each component have been printed on the PCB.

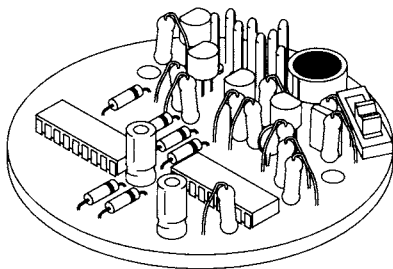
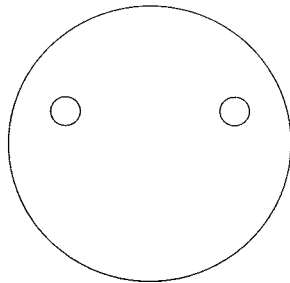

step 1: Suggest you start from the low-key components first such as the resistors.

Part I.D.	Description	Color Code	Qty
R10/13	100 Ω	brn blk brn gold	2
R8/11	4.7K	yel vio red gold	2
R1	10K	brn blk ora gold	1
R7	22K	red red ora gold	1
R2/4/6/9/12	33K	ora ora ora gold	5
R3/5	2.7M	red vio grn gold	2

step 2: Mount Diodes, Capacitors, Transistors, Variable, resistor(VR), Mic IC, Slide switch, Pins.

Part I.D.	Description	Qty
D1/2/3/4/5/6	Diodes IN4148	6
C2	Ceramic Capacitor 47P	1
C1	Mylar Capacitor 103	1
C3/4	Electrolytic Capacitor 1uf	2
Q2/4	Transistor 8050	2
Q1/3	Transistor C945 or (1815)	2
VR	Variable Resistor 200K	1
MIC	Microphone	1
IC1	IC 4069	1
IC2	IC 4017	1
SW	Slide Switch	1
ML + -	 \varnothing 1.3mm pin	8
MR + -		
3V +		
9V +		
G		

6. Mechanical Assembly:

1 Gear box Assembly

Please refer follow drawing to assemble 2 sets of gear box.

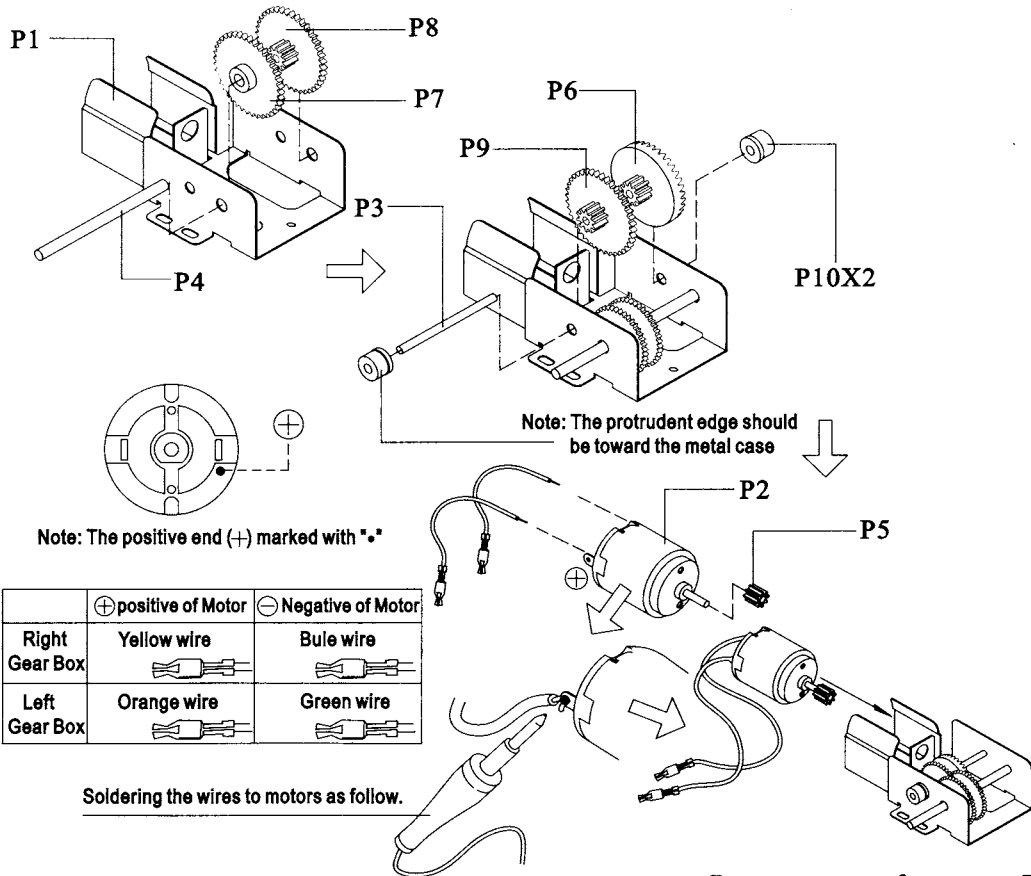
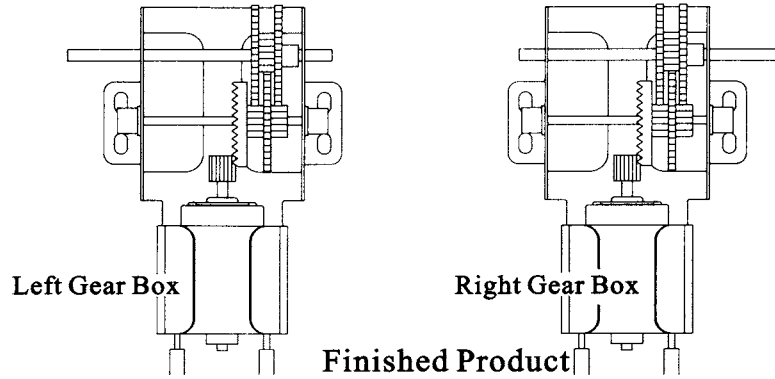

to be continued

2 Assemble 2 sets of gear box onto the wooden plate and hex posts

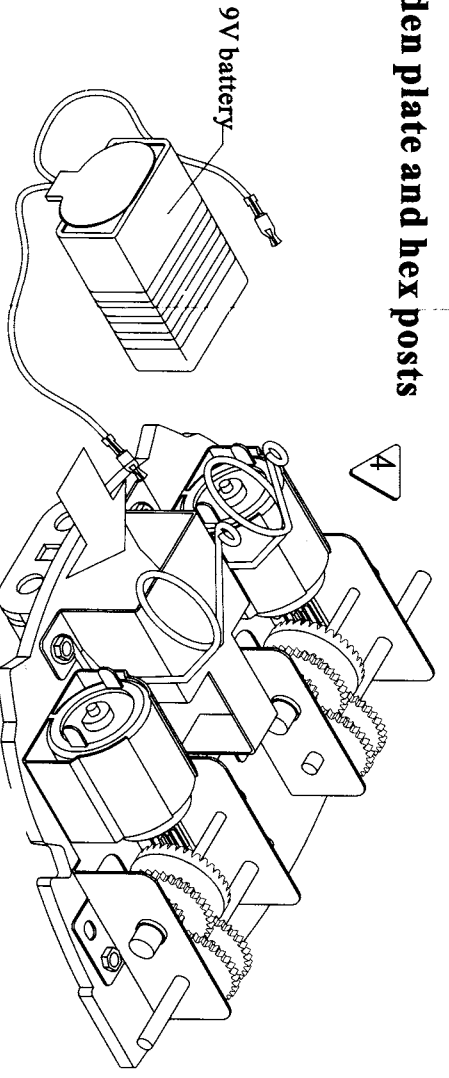
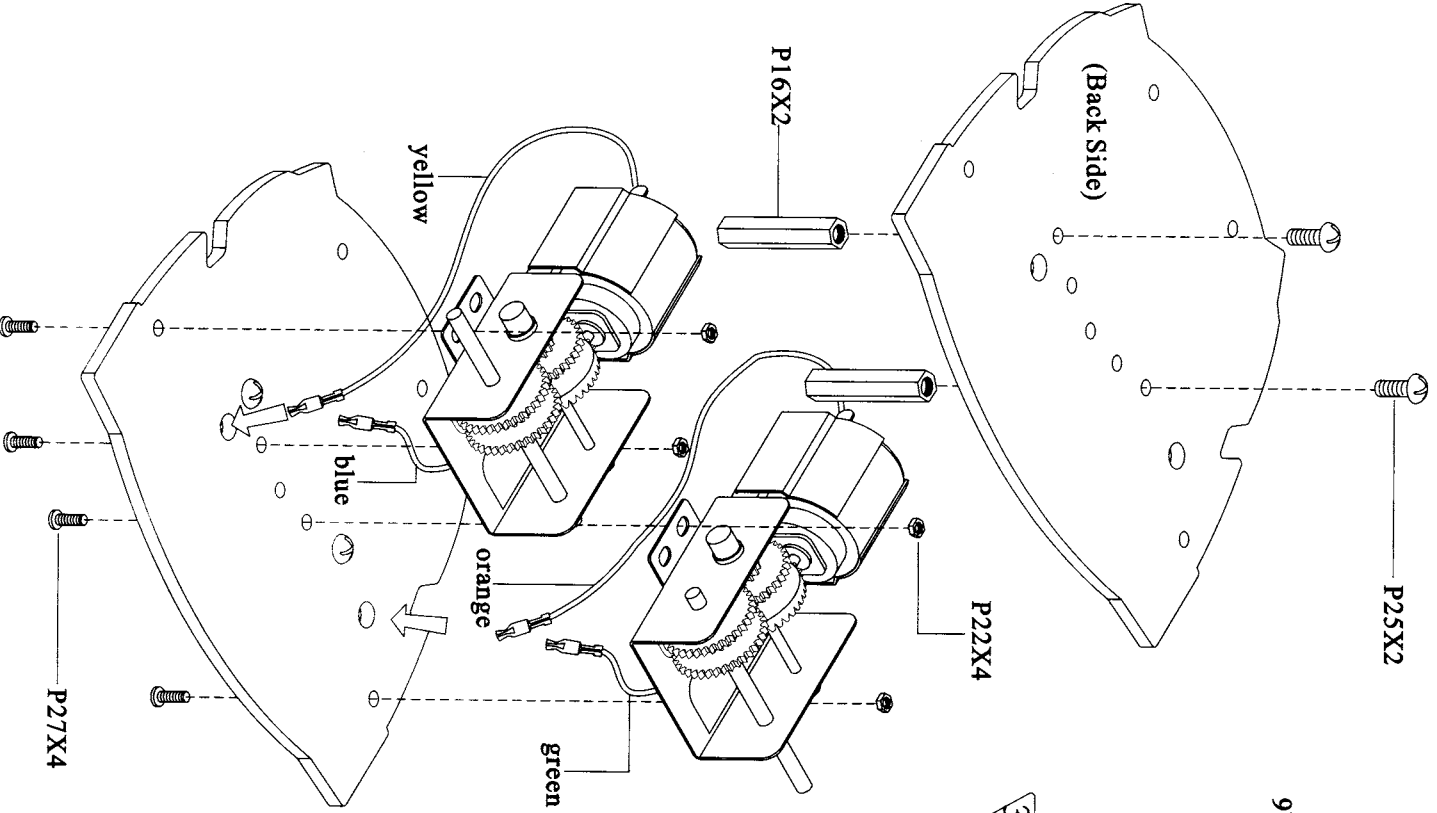

3 Assemble battery holder (DC9V) and front wheel brackets

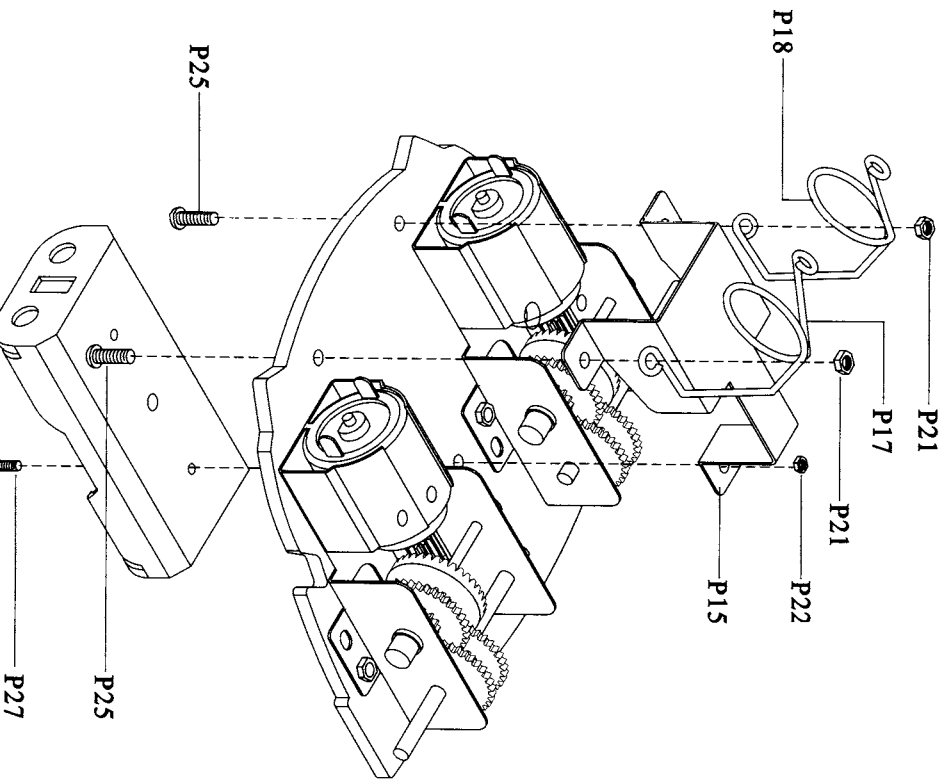

5 Assemble front wheel and rear wheels

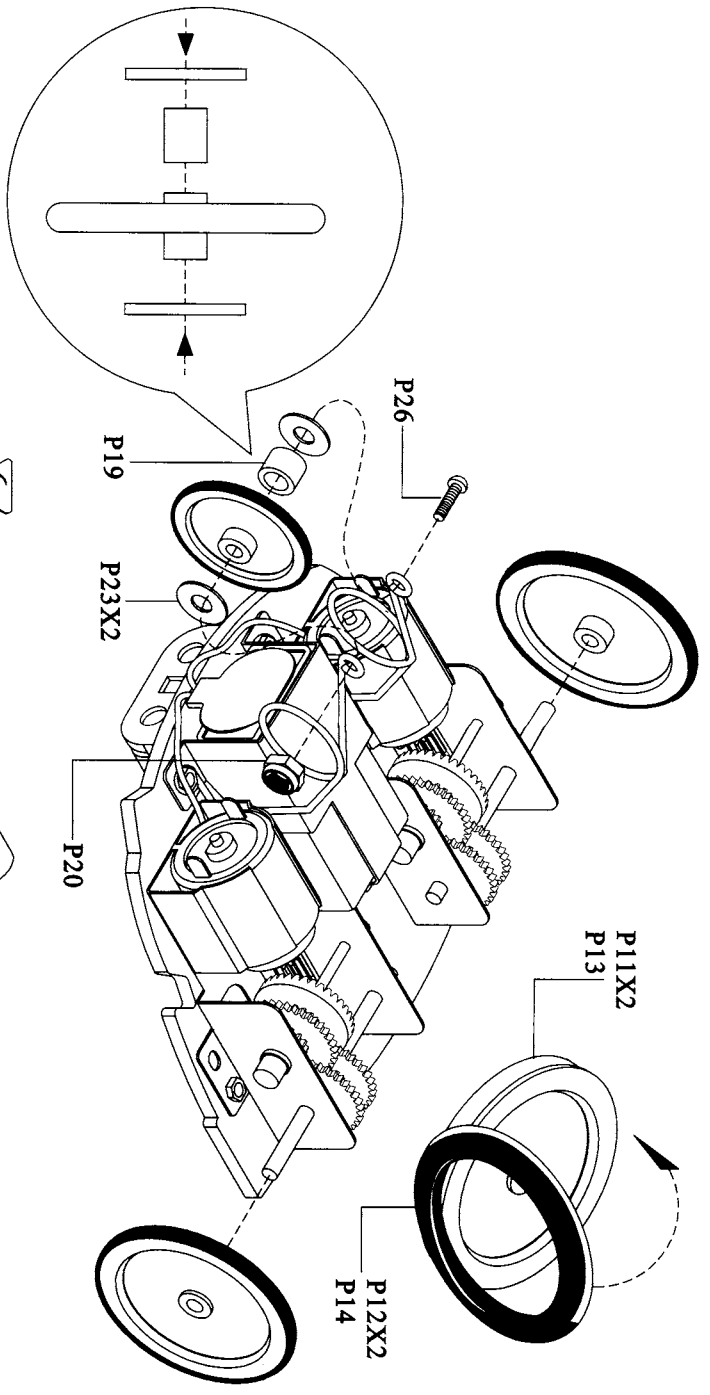

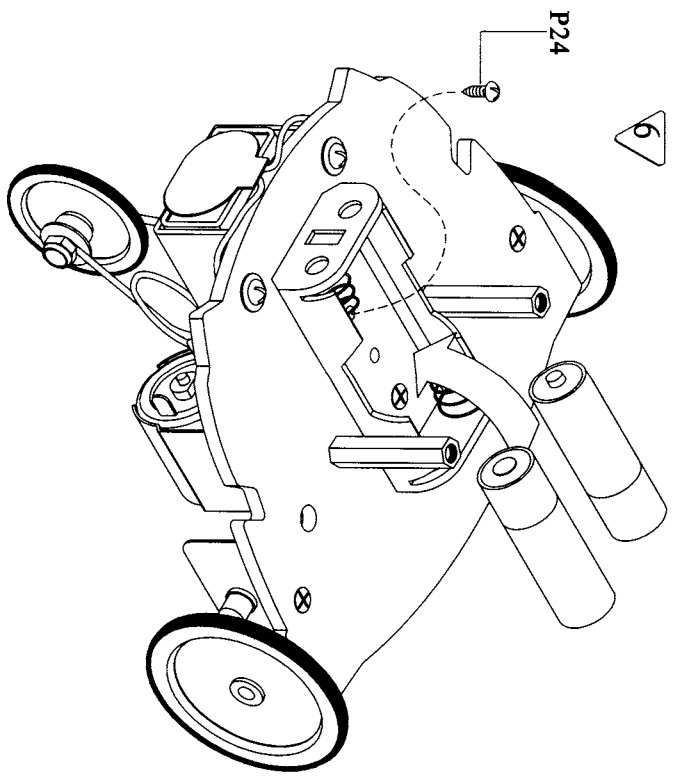

6



7 Assemble PCB

Wiring:

	A	B	C	D	E	F	G	H
	MR+	MR-	ML+	ML-	3V	G	9V	G
	yellow	blue	green	orange	+	-	+	-
					red	black	red	black
					3V		9V	

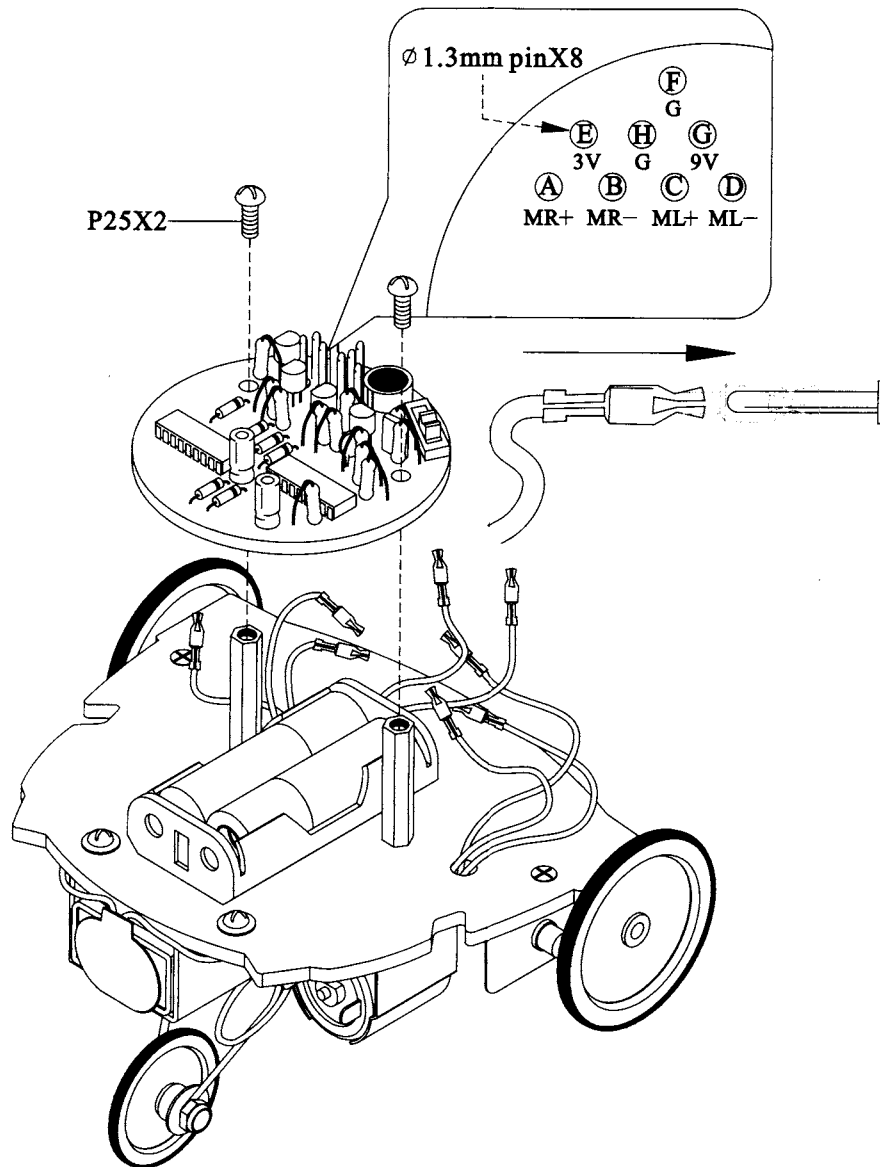

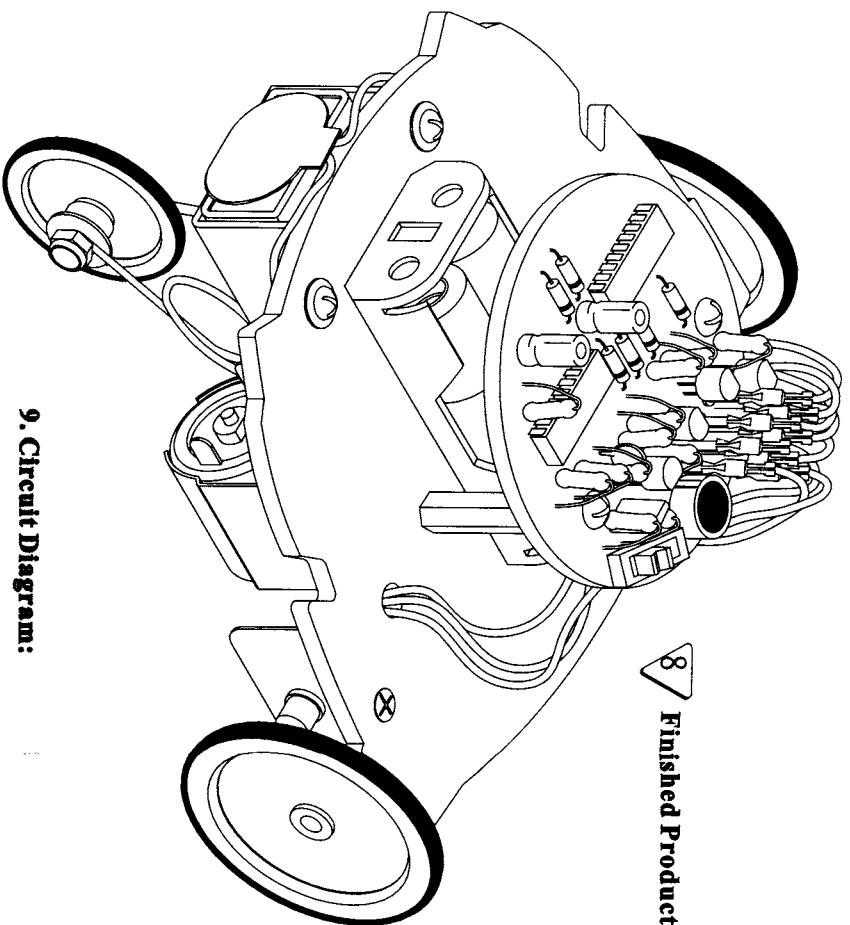

8 Finished Product

7. How it works:

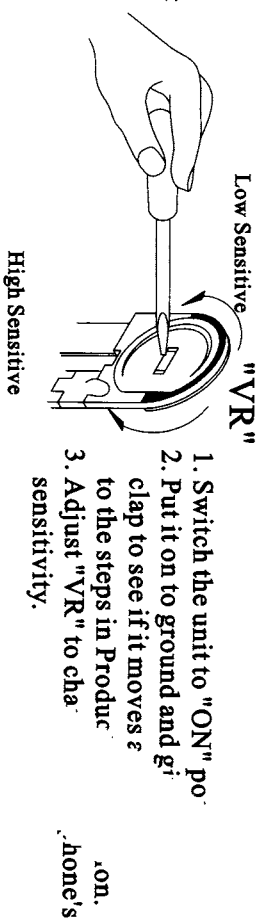

8. Troubleshooting:

1. Make sure all components on PCB are on right position especially note the polarity of Microphone, Transistors, Capacitors, IC, are in correct position.
2. Check all wiring are same as wiring diagram.
3. Adjust "VR" to Low Sensitive if the noise from gearboxes is too loud.
4. Noise from gearbox may interfere the microphone to receive signal, put few grease between gear face gear(P6) and 2mm shaft (P3) will reduce the noise
5. Note **NOT** to put any grease between 3mm shaft (P4) and gears (P7&P8).

9. Circuit Diagram:

